

# PowerView® Roller Blind 18VDC

The PowerView® M25T tubular motor is suited to be used with EOS® Xcell Roller Blinds from HunterDouglas.

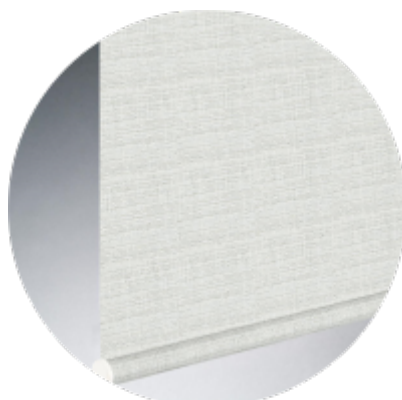

Roller Blind

## 1. Delivery condition

As standard, no remote control or hub is connected to the motor. No limits are set. Motor is default set to `roller blind` motor type. If the motor condition is unknown, perform the following steps.

### Note

The motor type (default `Roller blind`), can be changed with the the PowerView® Programmer software tool or PowerView® remote.

### 1.1. Check motor type

The motor can be programmed as a

- `Roller blind (default)`
- `Roller blind, slow scene speed disabled`
- `Twist® Roller Blind`
- `Twist® Roller Blind, slow scene speed disabled`

By reading out the LED sequence after power up, the motor type can be seen.

1.1.1 **Power up** the motor by connecting the power cable to the battery wand or power supply.

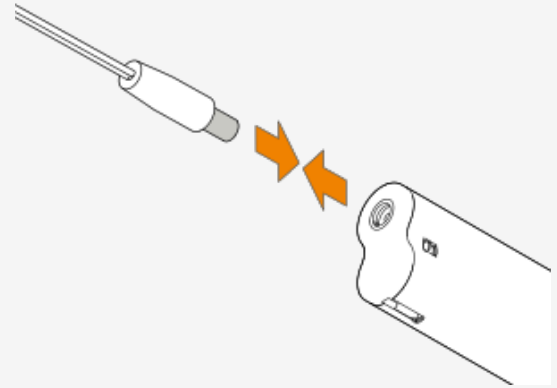

1.1.2 **Immediately Check** the motor button LED sequence after start up.

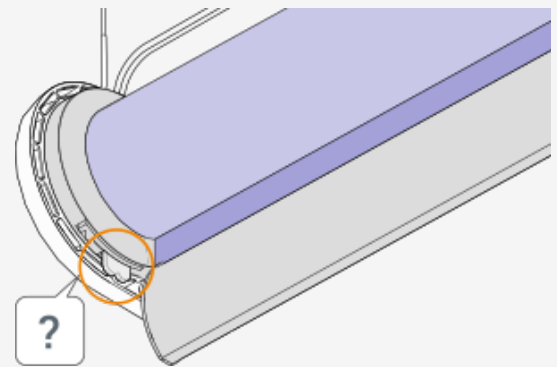

1.1.3 LED sequence of motor set to **Roller blind** type:



LED sequence of motor set to **Roller blind, slow scene speed disabled** type:

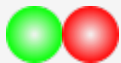

ALL GOOD!

LED sequence of motor set to **Twist® Roller Blind** type:



LED sequence of motor set to **Twist® Roller Blind, slow scene speed disabled** type:



NOT OK!

## 1.2. End limits reset (factory default)

This procedure will erase all limits stored in the volatile motor memory. It will not clear the Network ID and Group assignments.

 **Note**

This procedure can be skipped for a fresh out of the box motor.

The motor will jog 2x when receiving any PowerView® command (e.g. Pressing the manual control button on the motor), to confirm no limits are set.

- 1.2.1 **Remove power** from the motor by disconnecting the power cable from the battery wand or power supply and **wait for 20 seconds**.

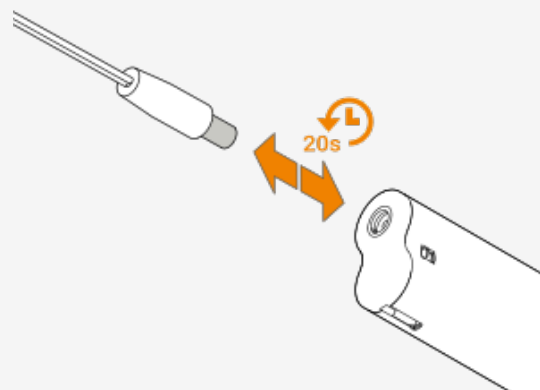

- 1.2.2 **Press and hold** the manual control button on the motor.

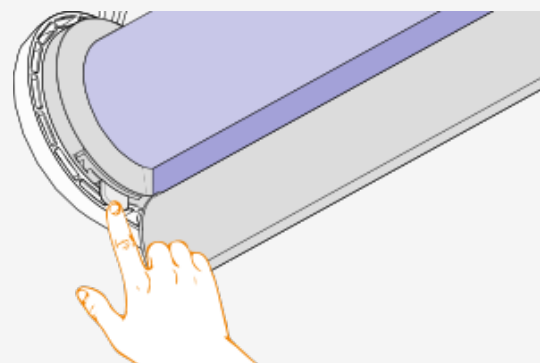

- 1.2.3 **Reconnect power** to the motor while **press and hold** the manual control button.

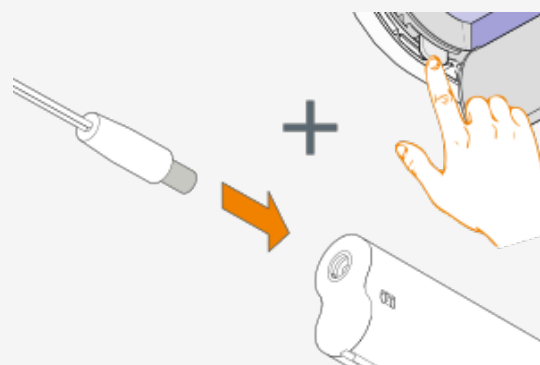

1.2.4 **Press and hold** the manual control button until the motor jogs 1x.

*The motor LED flashes red-orange after the motor jogs 1x.*

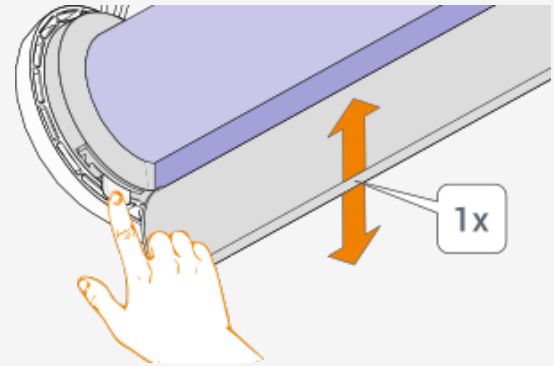

1.2.5 **Release** the manual control button.

The end limits have been cleared.

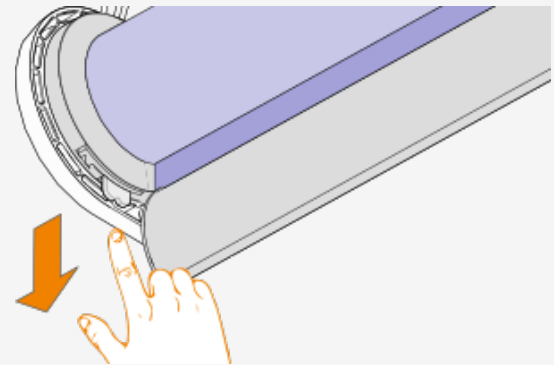

### 1.3. Network reset

This procedure will erase all network data stored in the motor, including Network ID and Group assignments. It will not clear the end limits. Completing a Network reset will prevent a PowerView® remote or App from operating the window covering until it is reprogrammed.

1.3.1 **Press and hold** the manual control button on the motor for 12 seconds.

*The blind will jog 1x at 6 seconds and a second time at 12 seconds.*

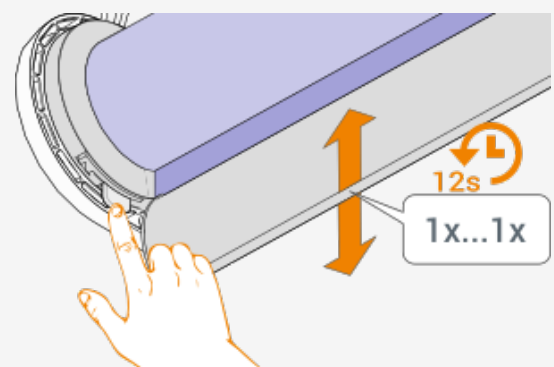

1.3.2 **Release** the manual control button after the second jog.

The Network ID and Group assignments have been cleared.

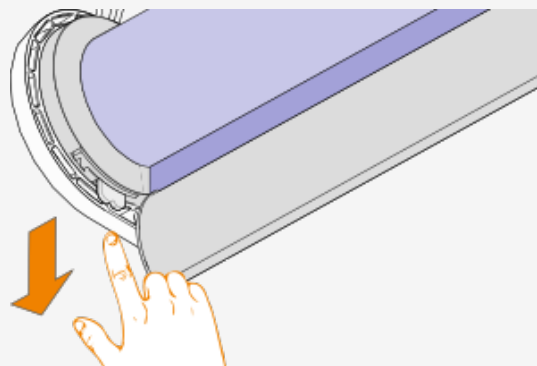

## 2. Pairing a remote

A PowerView® remote can control up to 6 individual groups of blinds (buttons 1 to 6 at the top of the remote). The instructions below assign a blind to group 1.

2.1 **Locate** the manual control button on your blind.

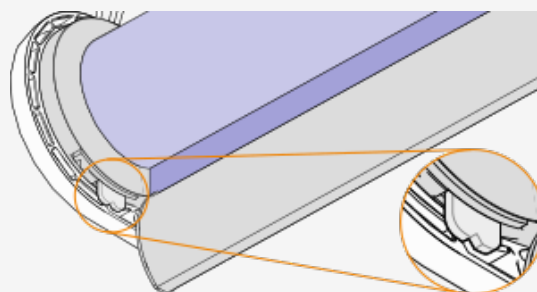

2.2 **Press and hold** the  stop button for 6 seconds.

*Keep pressing until the remote lights start blinking.*

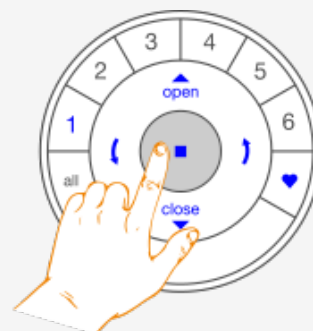

2.3 **Press** the  group1 button.

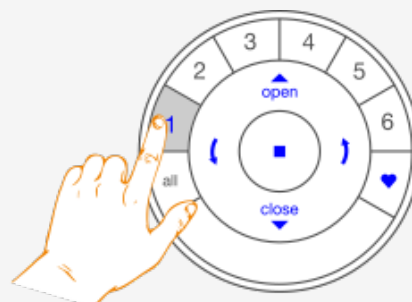

**⚡ IMPORTANT**

Watch out to perform steps 2.4 and 2.5 within 3 seconds!

2.4 **Press and hold** the manual control button .

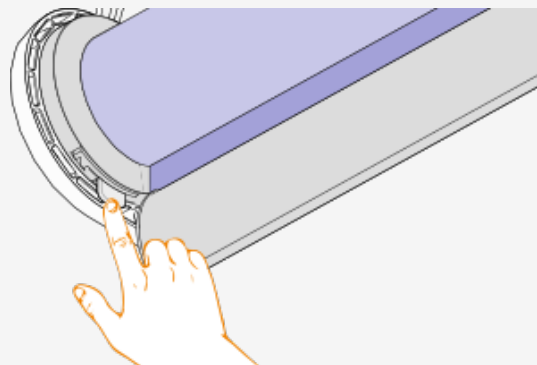

2.5 **Press** the ▲ open button.

*The blind will jog 1x.*

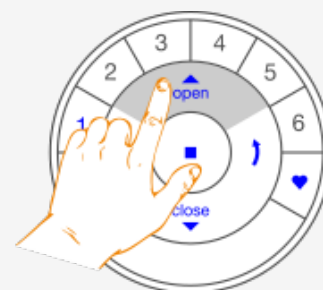

2.6 **Release** the manual control button .

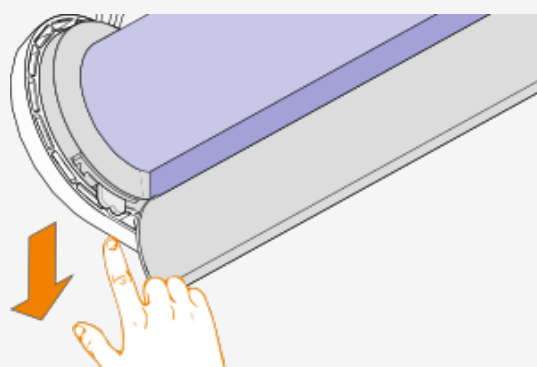

2.7 **Press and hold** the ■ stop button for 6 seconds.

*Keep pressing until the remote lights stop blinking.*

The remote will exit programming mode automatically after 20 seconds.

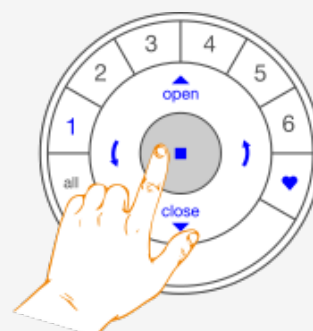

## 3. Checking motor direction

### IMPORTANT

Reversing motor direction is only possible with a fresh out of the box motor (no limits set) or when the end limits are **reset**. Before any limits are programmed, the motor direction has to be checked and reversed if needed. If the top or bottom Limit is already set, and the motor direction has to be reversed, perform a **reset** before continuing.

### 3.1. Put motor in program mode

#### IMPORTANT

Watch out to perform steps 3.1.1 and 3.1.2 within 3 seconds!

3.1.1 **Press and hold** the manual control button.

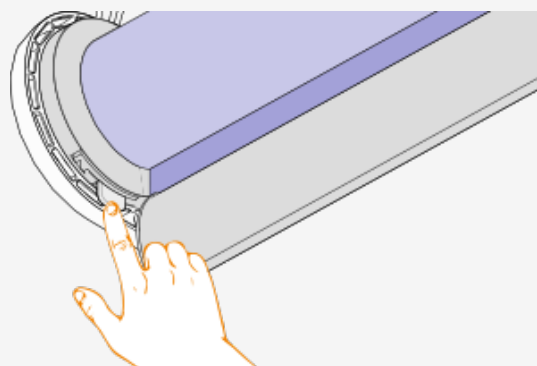

3.1.2 **Press** the ▲ open button.

Make sure **1** group1 on the remote is selected.

*The blind will jog 1x.*

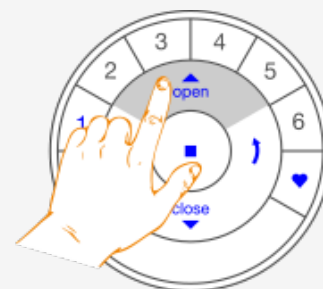

3.1.3 **Release** the manual control button .

*The motor LED turns red to acknowledge the motor is in program mode.*

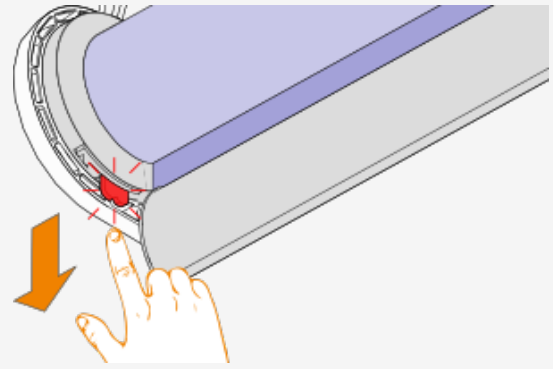



## 3.2. Check and confirm

### IMPORTANT

Watch out to perform steps 3.2.1 and 3.2.2 immediately after each other to avoid mechanical damage!  
Carefully read them first before executing!

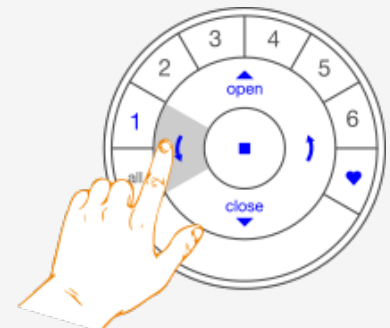
3.2.1 **Press** the  arrow down button to check motor direction.



3.2.2.A If the blind moves **upwards**, immediately **Press** the  stop button.

Motor direction NOT OK!

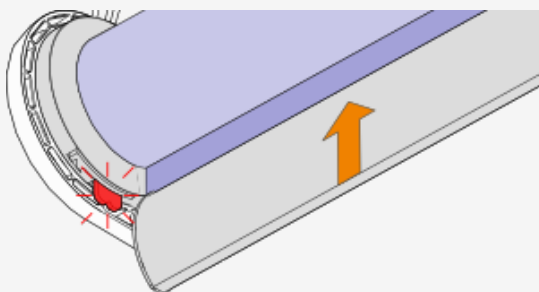

3.2.2.B If the blind moves **downwards**, Press the  stop button and continue with step 4.1.4

Motor direction OK!

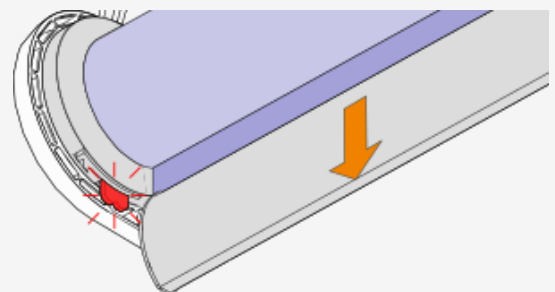



- 3.2.3 **Press and hold** the manual control button for 1 second to reverse motor direction.

*The blind will jog 1x to acknowledge the direction is reversed.*

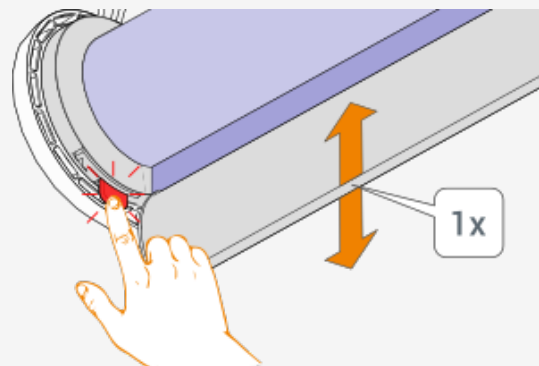

- 3.2.4 **Continue** with step 4.1.4

## 4. Setting end limits

It doesn't matter if you start with setting the open or the close limit first. In this description we start with the open (top) limit.

### Note

It is important to have the fabric of the blind tight around the tube.

### 4.1. Open limit (top)

- 4.1.1 **Press and hold** the manual control button .

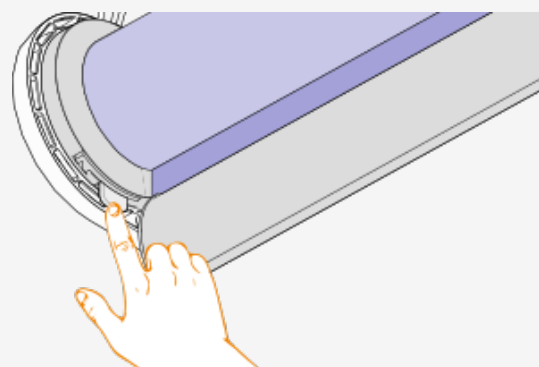

4.1.2 Press the ▲ open button.

Make sure **1** group1 on the remote is selected.

The blind will jog 1x.

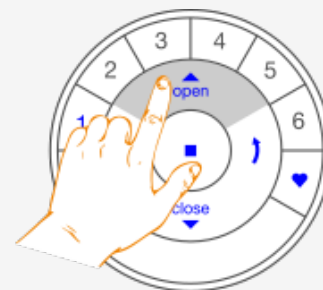

4.1.3 Release the manual control button.

The motor LED turns red to acknowledge the motor is in program mode.

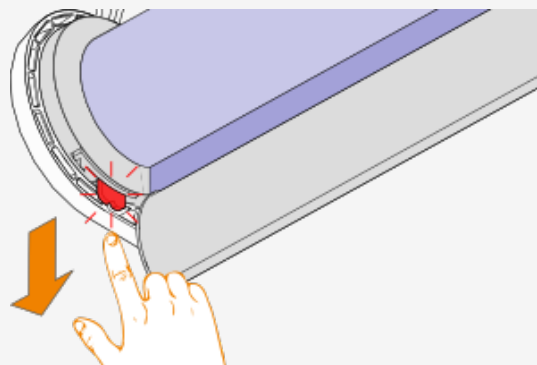

4.1.4 Use the ▲ open, ■ stop and ▼ close buttons to move the blind to the desired **top** position.

Use the **↵** arrow up and **⏴** arrow down buttons to fine tune the desired position.

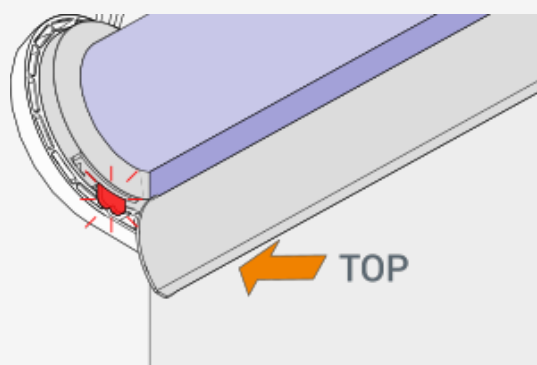
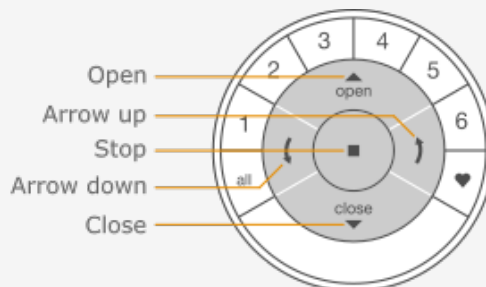

4.1.5 **Press and hold** the  stop button for 6 seconds.

**DO NOT** select a group on the remote!

*Keep pressing until the remote lights start blinking.*

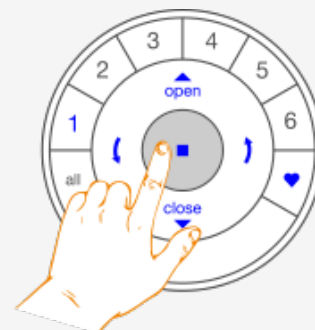

 **IMPORTANT**

Watch out to perform steps 4.1.6 and 4.1.7 within 3 seconds!

4.1.6 **Press and hold** the manual control button.

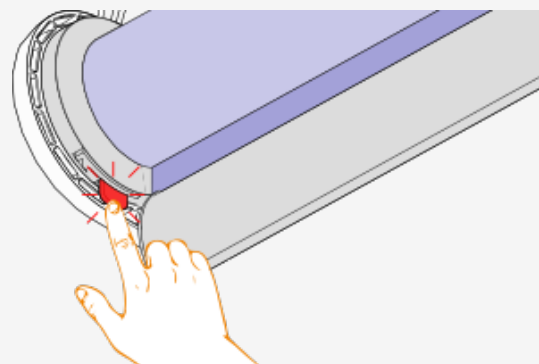

4.1.7 **Press** the  open button.

*The blind will jog 1x to acknowledge the limit is set.*

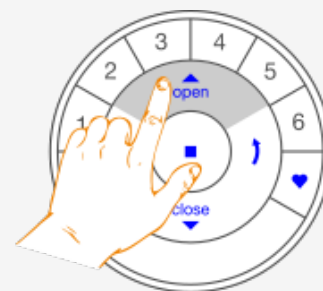

4.1.8 **Release** the manual control button.

*The motor LED turns off.*

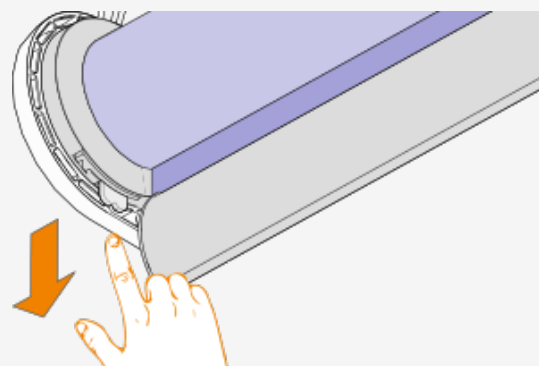

4.1.9 **Press and hold** the  stop button for 6 seconds.

*Keep pressing until the remote lights stop blinking.*

The remote will exit programming mode automatically after 20 seconds.

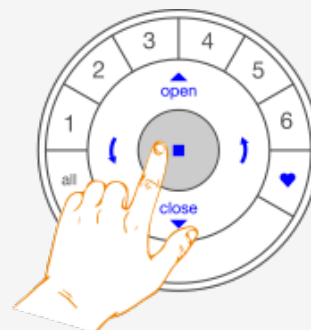

4.1.10 The top limit is set!

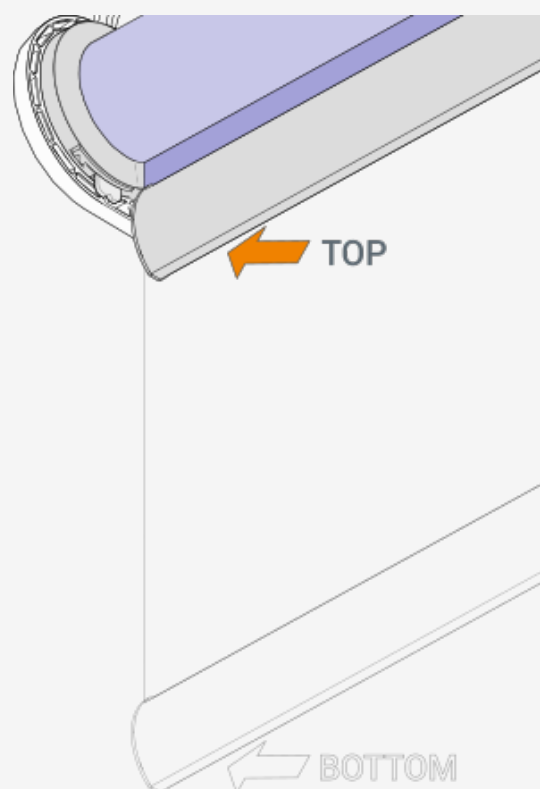

 **Note**

To re-position the top limit of the blind, repeat step 4.1 Open limit (top)

## 4.2. Close limit (bottom)

4.2.1 **Press and hold** the manual control button.

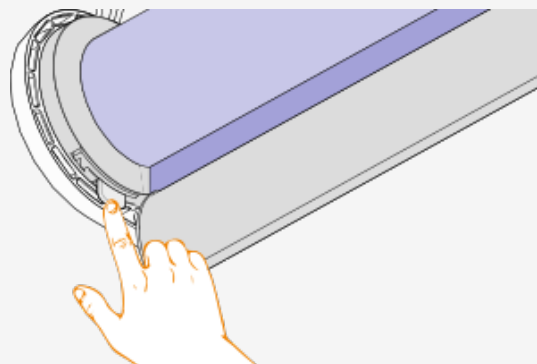

4.2.2 **Press** the ▼ close button.

Make sure **1** group1 on the remote is selected.

*The blind will jog 1x.*

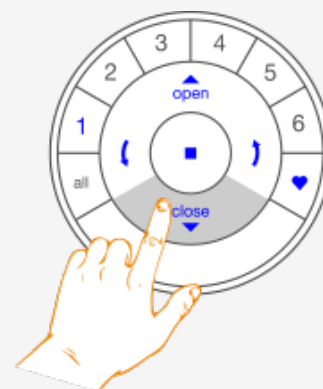

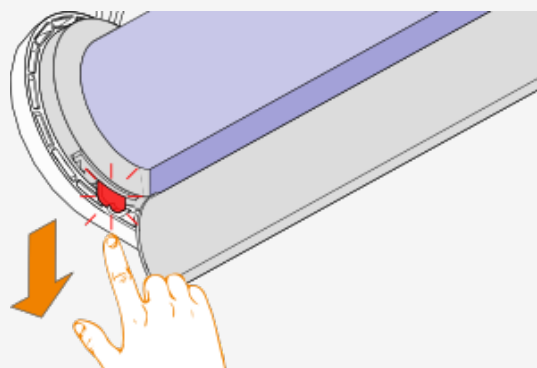

4.2.3 **Release** the manual control button.

*The motor LED turns red to acknowledge the motor is in program mode.*



4.2.4 Use the ▲ open, ■ stop and ▼ close buttons to move the blind to the desired **bottom** position.

Use the  arrow up and  arrow down buttons to fine tune the desired position.

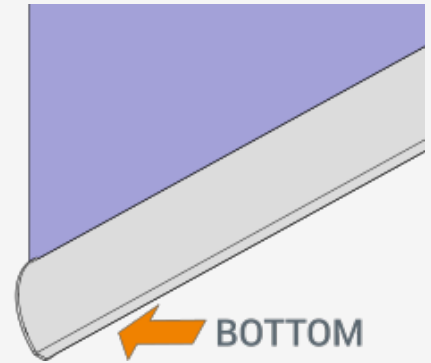
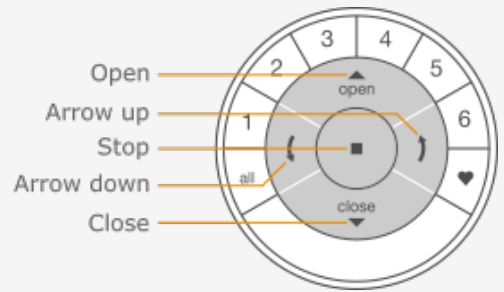

4.2.5 **Press and hold** the ■ stop button for 6 seconds.

**DO NOT** select a group on the remote!

*Keep pressing until the remote lights start blinking.*

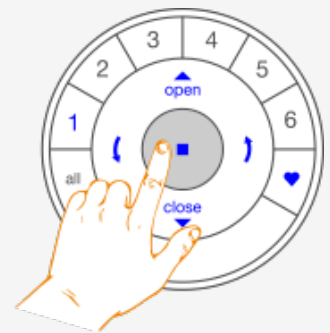

 **IMPORTANT**

Watch out to perform steps 4.2.6 and 4.2.7 within 3 seconds!

4.2.6 **Press and hold** the manual control button.

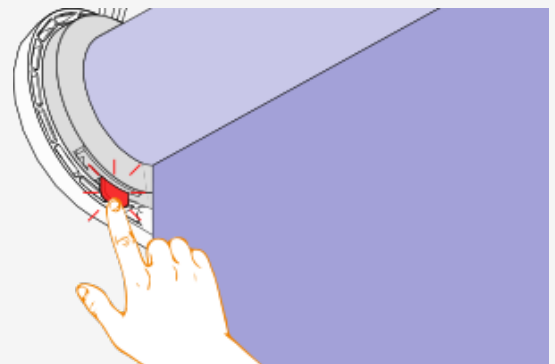

**4.2.7 Press the ▼ close button.**

*The blind will move to the top limit to acknowledge the bottom limit is set.*

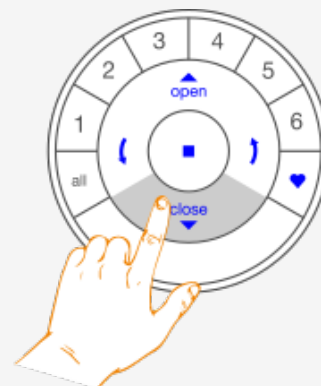
**4.2.8 Release the manual control button.**

*The motor LED turns off.*

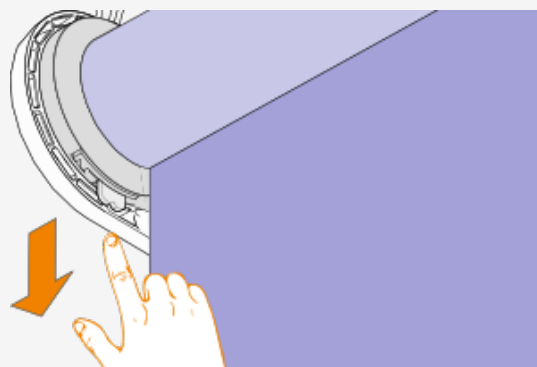
**4.2.9 Press and hold the ■ stop button for 6 seconds.**

*Keep pressing until the remote lights stop blinking.*

The remote will exit programming mode automatically after 20 seconds.

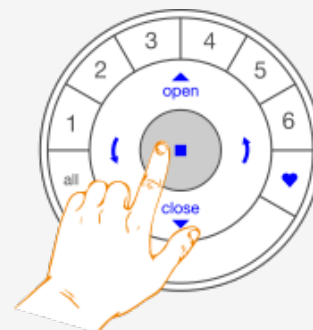

4.2.10

The bottom limit is set!

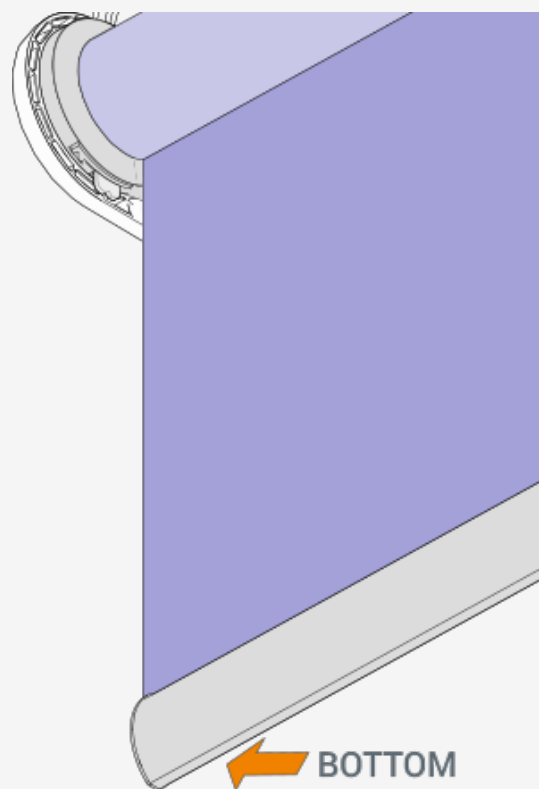

#### Note

To re-position the bottom limit of the blind, repeat step 4.2. Close limit (bottom)

## 5. Special motor functions

This chapter describes how to activate special functions with a standard PowerView® remote control:

### Disable slow scene speed

When activating a PowerView® scene with the PowerView® App, the motor's running speed will be the same as using the up and down buttons on a PowerView® remote. The slow scene speed (default) will be disabled.

### Change the motor type

Changing the motor type was only possible by using the [PowerView® Programmer](#) software tool. A standard PowerView® remote can be used instead.

## 5.1. Delivery conditions

Before these functions can be set, following conditions are required:

1. [Check motor type](#)
2. [No motor limits are set \(factory default\)](#)
3. [A PowerView® remote control is paired with the motor](#)



**⚡ IMPORTANT**

These special functionalities are only available from motor **serial number 0020153 onwards**.

**Always check** the motor's serial number on the product label.

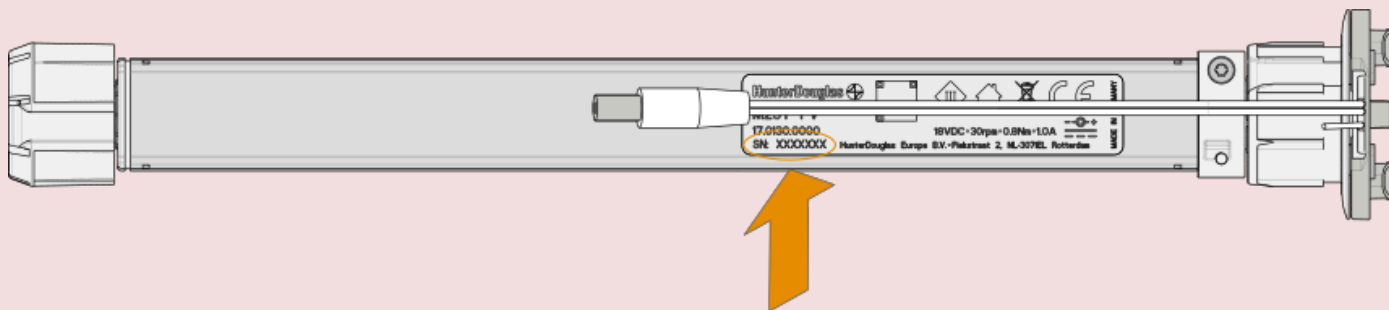

## 5.2. Enable Roller blind type & Disable slow scene speed

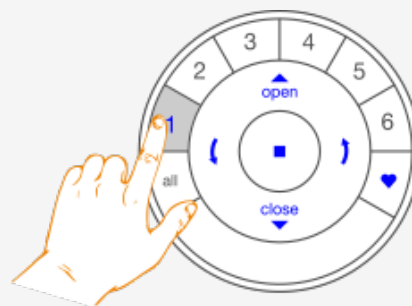

5.2.1 **Select** the right group on the remote.

In our example, we select **1** group1 on the remote.



**⚡ IMPORTANT**

In the next steps, all buttons have to be pressed with a **second interval!**

1. **Press** the  stop button **3 times**.
2. **Press** the  open button.
3. **Press** the  heart button.

The LED sequence should read:



The blind will jog 1x to acknowledge.

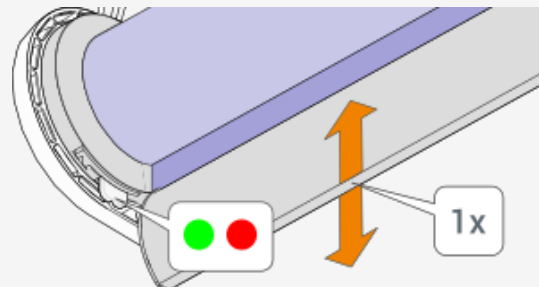

5.2.3 **Remove power** from the motor by disconnecting the power cable from the battery wand or power supply and **wait for 20 seconds**.

Do not forget this step! The motor needs to reboot to activate the function.

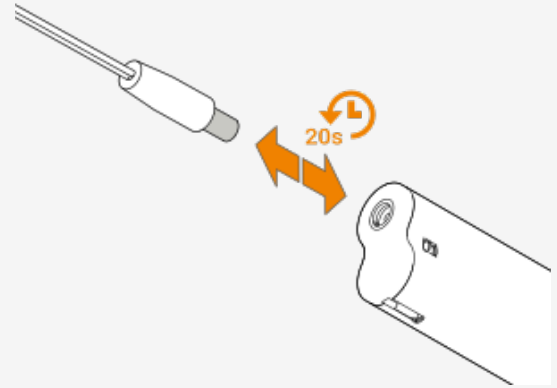

### 5.3. Enable Roller blind type

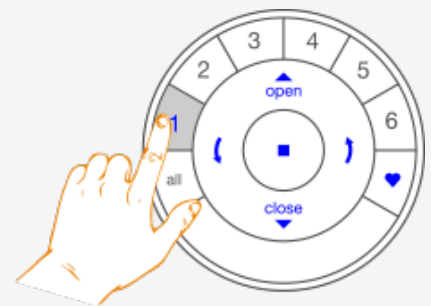

5.3.1 **Select** the right group on the remote.

In our example, we select **1** group1 on the remote.



 **IMPORTANT**

In the next steps, all buttons have to be pressed with a **second interval!**

- 5.3.2
1. **Press** the  stop button **3 times**.
  2. **Press** the  open button.
  3. **Press** the  open button.

The LED sequence should read:



The blind will jog 1x to acknowledge.

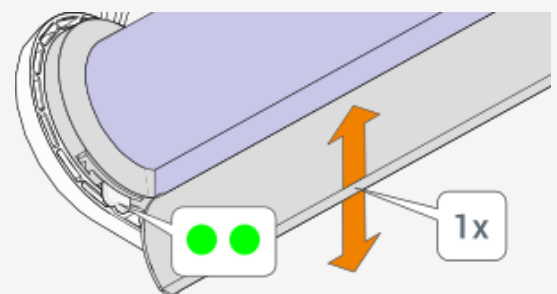

5.3.3 **Remove power** from the motor by disconnecting the power cable from the battery wand or power supply and **wait for 20 seconds**.

Do not forget this step! The motor needs to reboot to activate the function.

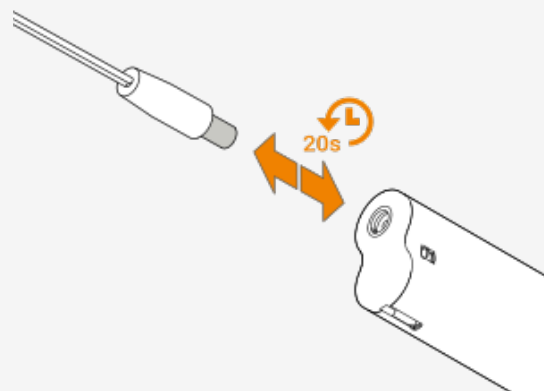

## 6. Motor control button LED

The motor control button LED gives an indication of the motor status. The LED can flash RED, ORANGE or GREEN. Below is an overview of all possible combinations.

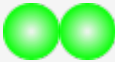
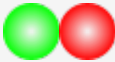
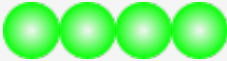
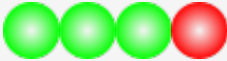
Sequence	Explanation
<b>After power up</b>	
	Restart / Start up
	Blind type: Roller blind
	Blind type: Roller blind, slow scene speed disabled
	Blind type: Twist® Roller Blind
	Blind type: Twist® Roller Blind, slow scene speed disabled
<b>After reset</b>	



End limits reset (factory default),  
see [chapter 1.2](#)



Network reset on manual control button release,  
see [chapter 1.3](#). Blind type: Roller blind



Network reset on manual control button release,  
see [chapter 1.3](#). Blind type: Twist® Roller Blind

## Battery operation



Low battery indication (< 11.0V).  
The blind will run in slow mode and can only be send upwards.



Ultra low battery indication (< 8.5V).  
The blind will not run anymore. Change the batteries.

## Others



The maximum motor current has been reached.  
E.g. The blind is stuck at an obstacle.



Steady red LED.  
The motor is in program mode (during limit setting).

## Important notice

Hunter Douglas Europe B.V. and its affiliates (Hunter Douglas) reserve the right to make corrections, enhancements, improvements and other changes to its products and services, and to discontinue any product or service. Buyers should obtain the latest relevant information before placing orders and should verify that such information is current and complete. All products (also referred to herein as "components") are sold subject to Hunter Douglas' terms and conditions of sale supplied at the time of order acknowledgment. Hunter Douglas warrants performance of its components to the specifications applicable at the time of sale, in accordance with its standard warranty terms. Testing and other quality control techniques are used to the extent Hunter Douglas deems necessary to support this warranty. Except where mandated by applicable law, testing of all parameters of each component is not necessarily performed. Hunter Douglas assumes no liability for applications assistance or the design of Buyers' products. Buyers are responsible for their products, applications and interfaces using Hunter Douglas components. To minimize the risks associated with Buyers' products and applications, Buyers should provide adequate design and operating safeguards. Hunter Douglas does not warrant or represent that any license, either express or implied, is granted under any patent right, copyright, mask work right, or other intellectual property right relating to any combination, machine, or process in which Hunter Douglas components or services are used. Information published by Hunter Douglas regarding third-party products or services does not constitute a license to use such products or services or a warranty or endorsement thereof. Use of such information may require a license from a third party under the patents or other intellectual property of the third party, or a license from Hunter Douglas under the patents or other intellectual property of Hunter Douglas. Reproduction of Hunter Douglas information in Hunter Douglas data sheets is permissible only if reproduction is without alteration and is accompanied by all associated warranties, conditions, limitations, and notices. Hunter Douglas is not responsible or liable for any altered documentation. Information of third parties may be subject to additional restrictions. Resale of Hunter Douglas components or services with statements different from or beyond the parameters stated by Hunter Douglas for that component or service voids all express and any implied warranties for the associated Hunter Douglas component or service and is an unfair and deceptive business practice. Hunter Douglas is not responsible or liable for any such statements. Buyers acknowledge and agree that they are solely responsible for compliance with all legal, regulatory and safety-related requirements concerning its products, and any use of Hunter Douglas components in its applications, notwithstanding any applications-related information or support that may be provided by Hunter Douglas. Buyers represent and agree that they have all the necessary expertise to create and implement safeguards which anticipate dangerous consequences of failures, monitor failures and their consequences, lessen the likelihood of failures that might cause harm and take appropriate remedial actions. Buyers fully indemnify Hunter Douglas and its representatives against any damages arising out of the use of any Hunter Douglas components in safety-critical applications.