

# PowerView® VVB 18VDC motor

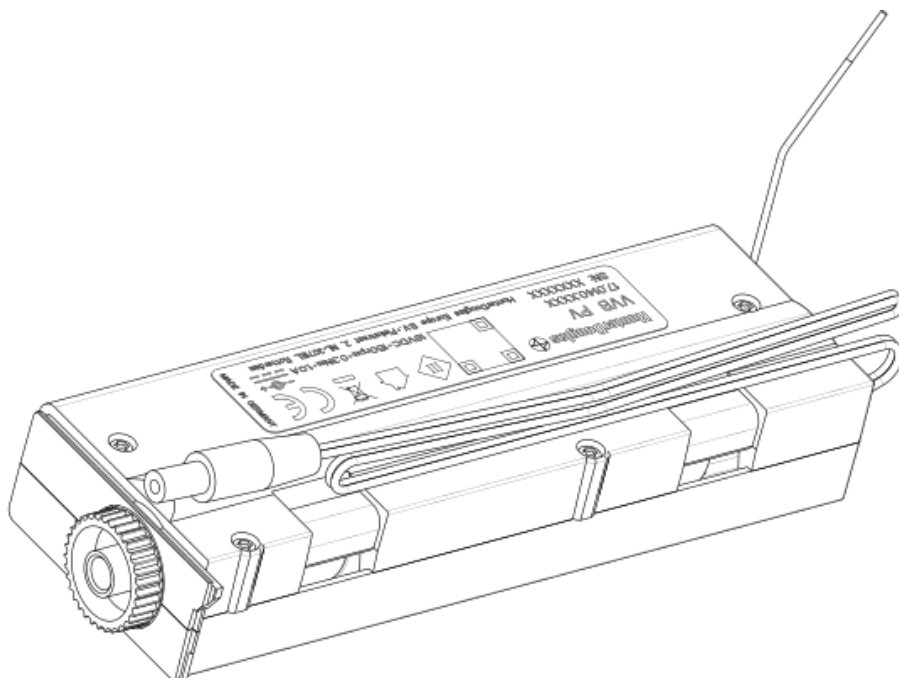

## Features & benefits

### PowerView® Motorisation

The reddot award winning control system enables your window coverings to be wirelessly operated. The motor is specifically designed for Vertical blinds and available in colour-coordinated white, light grey or black housing and end cap.

### Smooth operation

Starting from any position, the motor has a slow start slow stop function with regulated speed control for a better quality feel of movement. Besides the normal operation mode, a fast speed toggle with the up/down buttons on the PowerView® remote can be used.

### Tilt anywhere

The Vertical blind can be tilted from any position in slow speed mode by using the arrow buttons on the PowerView® remote.

### Designed with safety in mind

Along with the added convenience of cordless operation, PowerView® Motorisation creates a safer environment for homes with young children and pets.

### Battery Power makes it easy

The PowerView® Vertical blind is battery powered, making it incredibly easy to install, operate and maintain. The battery pack is hidden behind the product or mounted on any flat surface. A power supply is optionally available.

## Technical data

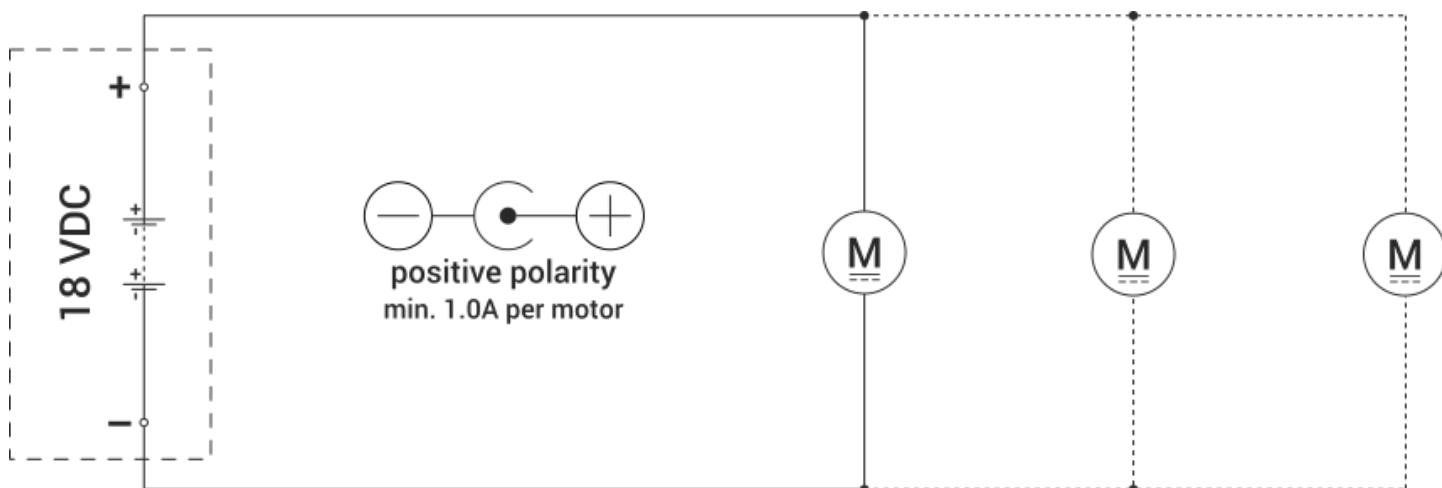



Rated voltage (VDC)	18
Type of connection	DC plug (i.d. 2.1mm; o.d. 5.5mm)
Nominal torque (Nm)	0.8
Nominal speed (m/s)	3.36
Fast speed (m/s)	4.50
Scene speed (m/s)	2.24
Tilting speed (mm/s)	6
Max. current consumption (A)	1.2
Protection rate	IP 40
Duty rating	4 min. on / 8 min. off
Operation temp. (°C)	0...+60
Power cable length (m)	0.3
Power cable colour	White

Weight (kg) 0.15

Approvals CE

Radio frequency (GHz) 2.4

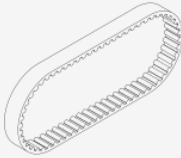
## Accessoires

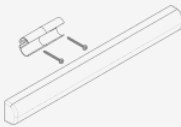
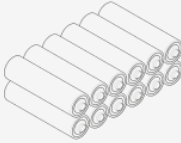
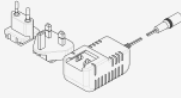
Description	Product code	Packing Unit	Figure
Toothed belt	17.0141.0000	184 pcs	
Battery tube 18V	17.0349.0000	10 pcs	
Battery clip	17.0142.0000	200 pcs	
Battery tube 18V mounting kit	17.0350.0000	40 pcs	
AA battery set (12 pcs)	17.2426.0000	24 pcs	
Power supply 18V, 1A	17.2424.0204	1 pc	

Power supply HT-18, 1A

17.0343.0000

5 pcs

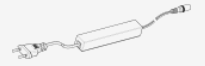

## Dimensions

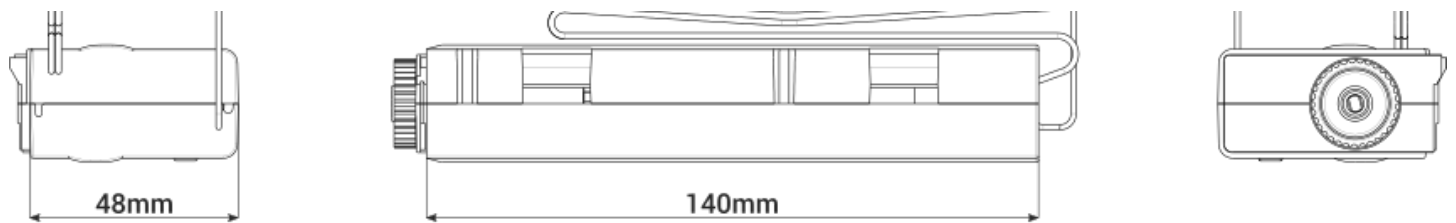

## Logistics / Applications

Article number

white / 17.0140.0155  
black / 17.0140.1858  
grey / 17.0140.0952

Min. order qty

10 pcs

Application

Left / Right / Split stack Vertical Blinds

Size limitations (mm)

Max. track length 4500

Weight limitations (kg)

Max. package weight 8.0

## Safety instructions

The motor may only be installed by qualified personnel who:

- have read and understood the mounting instructions of both blind and motor
- are familiar with the electronic safety aspects
- recognize and avoid danger which can be produced from the mechanical or electrical components
- always observe and are familiar with the local safety, labour regulations and laws



Never drop the motor!



Never drill into the motor!



Do not immerse into liquid!



Avoid collisions!



Do not cut any cables!

## Important notice

Hunter Douglas Europe B.V. and its affiliates (Hunter Douglas) reserve the right to make corrections, enhancements, improvements and other changes to its products and services, and to discontinue any product or service. Buyers should obtain the latest relevant information before placing orders and should verify that such information is current and complete. All products (also referred to herein as "components") are sold subject to Hunter Douglas' terms and conditions of sale supplied at the time of order acknowledgment. Hunter Douglas warrants performance of its components to the specifications applicable at the time of sale, in accordance with its standard warranty terms. Testing and other quality control techniques are used to the extent Hunter Douglas deems necessary to support this warranty. Except where mandated by applicable law, testing of all parameters of each component is not necessarily performed. Hunter Douglas assumes no liability for applications assistance or the design of Buyers' products. Buyers are responsible for their products, applications and interfaces using Hunter Douglas components. To minimize the risks associated with Buyers' products and applications, Buyers should provide adequate design and operating safeguards. Hunter Douglas does not warrant or represent that any license, either express or implied, is granted under any patent right, copyright, mask work right, or other intellectual property right relating to any combination, machine, or process in which Hunter Douglas components or services are used. Information published by Hunter Douglas regarding third-party products or services does not constitute a license to use such products or services or a warranty or endorsement thereof. Use of such information may require a license from a third party under the patents or other intellectual property of the third party, or a license from Hunter Douglas under the patents or other intellectual property of Hunter Douglas. Reproduction of Hunter Douglas information in Hunter Douglas data sheets is permissible only if reproduction is without alteration and is accompanied by all associated warranties, conditions, limitations, and notices. Hunter Douglas is not responsible or liable for any altered documentation. Information of third parties may be subject to additional restrictions. Resale of Hunter Douglas components or services with statements different from or beyond the parameters stated by Hunter Douglas for that component or service voids all express and any implied warranties for the associated Hunter Douglas component or service and is an unfair and deceptive business practice. Hunter Douglas is not responsible or liable for any such statements. Buyers acknowledge and agree that they are solely responsible for compliance with all legal, regulatory and safety-related requirements concerning its products, and any use of Hunter Douglas components in its applications, notwithstanding any applications-related information or support that may be provided by Hunter Douglas. Buyers represent and agree that they have all the necessary expertise to create and implement safeguards which anticipate dangerous consequences of failures, monitor failures and their consequences, lessen the likelihood of failures that might cause harm and take appropriate remedial actions. Buyers fully indemnify Hunter Douglas and its representatives against any damages arising out of the use of any Hunter Douglas components in safety-critical applications.